

⑩  Europäisches Patentamt
European Patent Office
Office européen des brevets

⑪ Publication number: **0 149 762**
A1

⑫ **EUROPEAN PATENT APPLICATION**

⑬ Application number: 84114411.6

⑭ Int. Cl.⁴: **G 06 F 1/00**
G 06 F 3/033

⑮ Date of filing: 28.11.84

⑯ Priority: 30.11.83 GB 8331951

⑰ Date of publication of application:
31.07.85 Bulletin 85/21

⑱ Designated Contracting States:
DE FR IT NL SE

⑲ Applicant: International Standard Electric Corporation
320 Park Avenue
New York New York 10022(US)

⑳ Inventor: Crossland, William Alden
15, School Lane
Harlow Essex(GB)

㉑ Inventor: Peters, Jack Rowland
The Pond House Great Cranfield
Near Dunmow Essex(GB)

㉒ Inventor: Smith, Harry John
66, Elmwood
Sawbridgeworth Herts.(GB)

㉓ Inventor: Astorino, Frank
40, Maple Lane
Essex Falls NJ 07021(US)

㉔ Representative: Graf, Georg Hugo, Dipl.-Ing. et al.
c/o Standard Elektrik Lorenz AG Patent- und
Lizenzwesen Postfach 500 529 Kurze Strasse 8
D-7000 Stuttgart 30(DE)

㉕ Office terminal.

㉖ The display unit of an office terminal is comprised of a smectic flat panel display module (2) which is supported by a support module (1). The terminal also includes a keyboard (4). The display module (2) may be removed from the support module (1) and has its own processor, storage, control and power means to enable operation independently of the support module, which contains its own processor, storage, control, interface and other means and is mains operated. The display module (2) may incorporate a touch sensitive overlay to effect manipulation of the display. The support module (1) may incorporate a telephone unit.

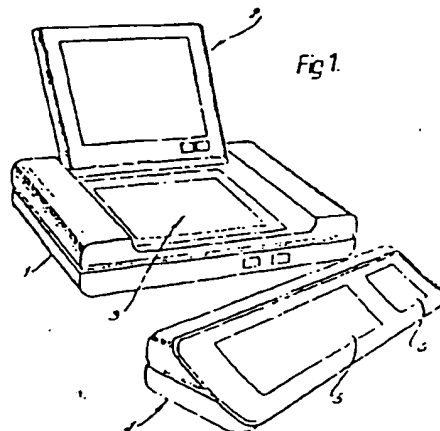

EP 0 149 762 A1

Graydon Printing Company Ltd

W.A.Crossland - J.R.Peters -
H.J.Smith - F.Astorino 43-17-7-3

5

10

OFFICE TERMINAL

This invention relates to office terminals and in particular to office terminals incorporating visual display units.

15

Eitherto the visual display units in office terminals have been comprised of cathode ray tube (CRT) displays which have various disadvantages including size and lack of tolerance to high levels of ambient lighting.

20

According to the present invention there is provided an office terminal incorporating a visual display unit comprised of a smectic flat panel display.

Embodiments of the present invention will now be described with reference to the accompanying drawings, in which:

25

Fig. 1 shows, somewhat schematically, a perspective view of an office terminal including a support module with two display modules and a keyboard;

30

Fig. 2 shows a side view of the office terminal of Fig. 1 and illustrates pivoting of one of the display modules;

35

Fig. 3 shows, somewhat schematically, a perspective view of an office terminal including a support module with one display module and a keyboard;

Fig. 4 shows a side view of the office terminal of Fig. 3 and illustrates pivoting of the display module;

Fig. 5 illustrates use of a display module independently of a support module therefore

Fig. 6 is a block functional diagram for the circulating of a display module, and

Fig. 7 is a block functional diagram for the circuitry of a support module.

5 The present invention is based on the recognition that the replacement of a cathode ray tube display by a flat panel display offers various advantages in terms of size, shape and aesthetic appeal, and that a smectic liquid crystal flat panel display, in particular,
10 will overcome various other disadvantages of cathode ray tube displays by virtue of providing a flicker-free display that can be ambiently lit at a wide range of ambient lighting levels.

Many office terminal constructions employing
15 flat panel displays can be envisaged and those illustrated in Figs. 1 and 2 and Figs. 3 and 4, respectively, are by way of example only. The embodiment of Figs. 1 and 2 incorporates two display panels whereas that of Figs. 3 and 4 incorporates a single display panel.

20 Referring firstly to Figs. 1 and 2, the office terminal illustrated therein comprises a support module 1, a first flat panel display module 2, a second flat panel display 3 and a keyboard 4. The display 3 is fixed within the support modules whereas the display module 2
25 is shown as hinged (pivoted) to the support module 1, so that it may be closed down onto the display 3 or tilted back at any required viewing angle, including tilting right back as illustrated in Fig. 2. The display module 2 is also removable from the support module 1 and capable
30 of use independently thereof, either, as will be apparent in more detail from the following description, completely independently and portably (Fig. 5) when internal batteries will provide the necessary operating power, or when the display module and support module are connected
35 together by a suitable cable the user may position the display module in any position more convenient for his purposes than on the support module. The two display

panels 2 and 3 of this terminal arrangement permit the display of two pages of information at once, thus facilitating comparison thereof. Flat panel displays lend themselves more readily to multiplex embodiments than do cathode ray tube displays, because of their thinness.

The keyboard 4 may be conventional with regard to alphanumeric keys (not shown) which may be contained within areas 5 and 6 thereof, which areas may also contain other function keys. A conventional executive office terminal combines a telephone keyboard and a CRT display as one unit and the flat panel terminals provided by the present invention may, if required, also incorporate a full facility telephone unit. The telephone facilities need not interact directly with the display or the rest of the terminal. The keyboard 4 may have a cord or cordless interface with the support module 1 and, if telephone facilities are incorporated, there may be a cord or cordless telephone handset (not shown) or a "hands-free" microphone/receiver arrangement (not shown). The telephone unit may be incorporated in the support module.

Figs. 3 and 4 illustrate an embodiment of office terminal incorporating a single flat panel display module 7 which is pivotably mounted to a support module 8 at the front (in use) thereof in order to adopt a position most suitable for the operator as well as to be laid flat into the support module when not in use. A keyboard 9 has alphanumeric and other function keys, and as described with respect to the keyboard of Figs. 1 and 2 may have a cord or cordless interface with the support module, the latter enabling the display module mounted in the support module and the keyboard to be disposed anywhere convenient to the terminal operator on a working surface.

The display module (2-Fig. 1, 7-Fig. 3) may be interfaced with the support module (1-Fig. 1, 8-Fig. 3) in various ways. For example, the display module may

0149762

plug directly into the support module using a standard plug and socket combination together with a suitable physical locating and mechanical arrangement, or the display module may be electrically connected to the support module by a flexible cable having a plug at one end and a socket at the other. The cable plug could fit a socket at the support module and the cable socket could fit the display, or vice versa. The use of a cable would, as mentioned before, enable the display module to be operated with the support module's facilities available to it, but would allow the user freedom to position the display conveniently.

The or each display of the terminals is comprised of a large area smectic liquid crystal, for example, with a 184mm x 238mm display area and for example 24 lines of 80 characters. The display preferably has alphanumeric, graphic and picture forming capability using an electro-optical effect with an intrinsic unpowered memory. Such displays display information with a high contrast, bright information on a black background or black information on a white background, for example, approaching that of print on paper. Power is required for writing or erasing the display, but once written the display is unpowered permanent and flicker free.

It is proposed that the office terminals of the present invention be employed to fulfill many of the functional activities earned out within a normal office environment, and that the display should replace some if not all of the working papers, reports, filing systems, notepads and diaries generally found on an office worker's desk top. The or each display is provided with means such as a touch sensitive overlay to provide a means of locating required information, such as menu, mail, address, etc by pointing to and touching a data area on the display to initiate a command. The terminal employs system operating protocols to ensure that the

locating of information is achieved in a logical manner. The office terminals will thus allow existing work practices to be followed but with greatly increased efficiency and flexibility. The facilities included in the terminal may include some or all of the following, namely; receiving filed documents; electronic mail; scheduling (diary planning, calender); form completion; text review and limited editing; local processing (calculations, charts); business graphics; transactions.

10 The main modules, that is the display module and the support module, will now be described in greater detail. The flat panel display module basically contains drive circuitry, a local memory for a multiple page store, supporting intelligence (processing) and a battery for independent operation. The display module is capable of working independently allowing the user to scan and view the documents held in the memory. In order to enable simple commands to be entered into the display module means such as the touch sensitive overlay mentioned above is provided. This touch sensitive input can have two modes of operation, one a supporting roll to the keyboard, the other as a main entry device when no keyboard is available. The overlay may be configured as a numeric key pad for compiling data or carrying out calculations when operating in the remote (independent) mode.

20 The support module is the facility support unit (processing and storage) and power supply for the overall terminal. It supports a range of application programs and interfaces, which programs enable the terminal to carry out many functions of the office workstation. It also contains an interface for the keyboard (cordless or otherwise) and support for communications protocols in order to link the terminal to a remote data base or computing facility.

35 Preferably the terminal goes into a "sleep" state to save power when not being used and is only

0149762

'woken up' when required to change the displayed information or receive data from an entry device.

A functional block diagram of a display module is shown in Fig. 6. It comprises a data input 10, a display screen interface 11, for a flat panel smectic liquid crystal display 12, under the control of a controller 13, and n-page (for example 20 page) store and interface 14, a touch sensitive overlay interface 15 for a touch sensitive overlay 16, a support module interface 17 and utilities (application levels) 18 such as data input and page search. The display module has a limited range of functions when operating independently of the support module, which functions include the scanning and display of stored information, with data entry from the touch sensitive overlay or, for example, a bar code wand (not shown) connected to the data input which module can then be used in a data gathering application, for example stock checking in a store or warehouse.

A functional block diagram of a support module is shown in Fig. 7. It comprises a display module interface 19, a connection 20 for a database processor and computer, an n-page store and interface 21, a main control unit and memory 22, a keyboard interface 23 for a keyboard 24, a communications interface 25 for a line 26, auxiliary interface 27 with a number of parts, for example, a printer or disk, an application function 28 and an operating system (not shown). The support module software may employ an existing operating system, for example MIRTOS, and includes facilities for executing programs concurrently sharing resources and information control. The real-time operating system contains memory management, flexible file and device handling, with fast response to interrupts and should have debugging facilities. The user/application software is closely linked to the operating system.

The drive circuitry of the display module comprises display drivers which enable information to be

written on the display and may be organised in matrix form. The touch sensitive overlay may comprise a transparent plastic film overlay supporting a conductor array for capacitive touch sensitive operation.

5 Preferably the display module employs CMOS technology which reduces the power requirements to a minimum. Preferably the controllers in the display module and the support module are comprised of microprocessors. The n-page stores in the display and support modules may be
10 comprised of semiconductor RAM. The microprocessor programs may be in ROM. The display module battery is preferably rechargeable from the support module. Voltage conversion means will be included in the display module in order to transform the battery output voltage to the
15 voltage necessary to power the smectic display matrix drivers. The support module is mains powered and contains the power supplies necessary to feed its own circuits and those of the display module when the latter is attached. Preferably manipulation of the display
20 content is largely effected via the touch sensitive overlay, whether in isolation or attached to the support module.

25

- 10 -

30

35

W.A.Crossland - J.R.Peters -
E.J.Smith - F.Astorino 34-17-7-3

C l a i m s

1. Office terminal incorporating a visual display module and a support module, wherein the support module contains processor, storage and control means and interface means for the display module, characterised in that the display
5 module is a smectic flat panel display (2, 7) and that the flat panel display module (2, 7) can be removed from the support module (1, 8) and used remotely therefrom.
2. Office terminal as claimed in claim 1, characterised in that the display module (2, 7) contains respective
10 processor, storage and control means, interface means for the support module (1, 8) and battery means to enable operation independently of the support module.
3. Office terminal as claimed in claim 1 or 2, characterised in that the smactic flat panel display (2, 7) in-
15 corporates a touch sensitive overlay for use in manipulating the display.
4. Office terminal as claimed in claim 3, characterised in that the touch sensitive overlay is active only for entering data when the display module (2, 7) is operated
20 independently of the support module (1, 8).
5. Office terminal as claimed in any one of claims 2 to 4 further including a keyboard (4, 9) having a corded or cordless interface with the support module (1, 8).

ZT/P-vHy/fö
26.11.1984

W.Crossland 34-17-7-3

6. Office terminal as claimed in any one of claims 2 to 5, characterised in that support module (1, 8) includes a telephone unit.

5 7. Office terminal as claimed in any one of claims 2 to 6, characterised in that the support module (1) includes a smectic flat panel display (3) which is not removable therefrom.

10 8. Office terminal as claimed in claim 7, characterised in that the smectic flat panel display (3) and the display module (2) are both incurable when the display module (2) is mounted to the support module (1) whereby to enable two separate pages of information to be viewed concurrently.

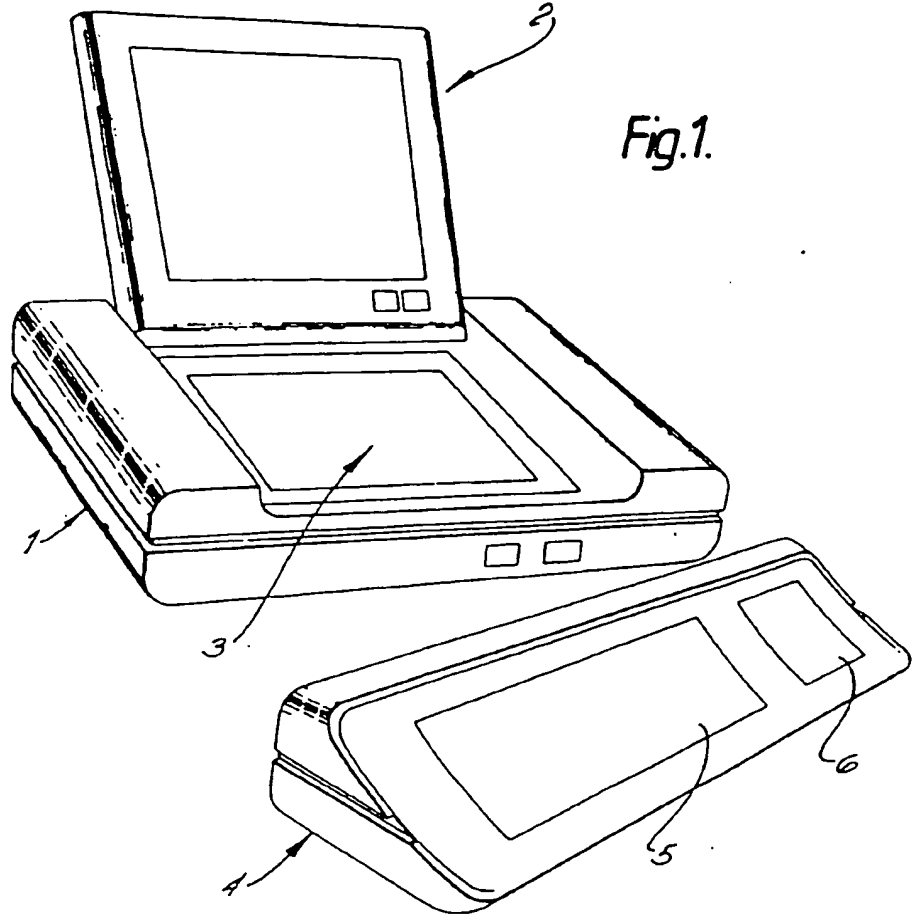
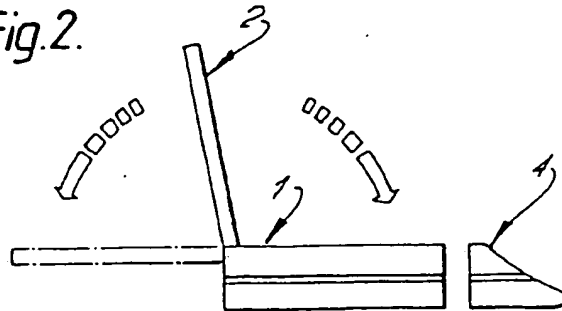
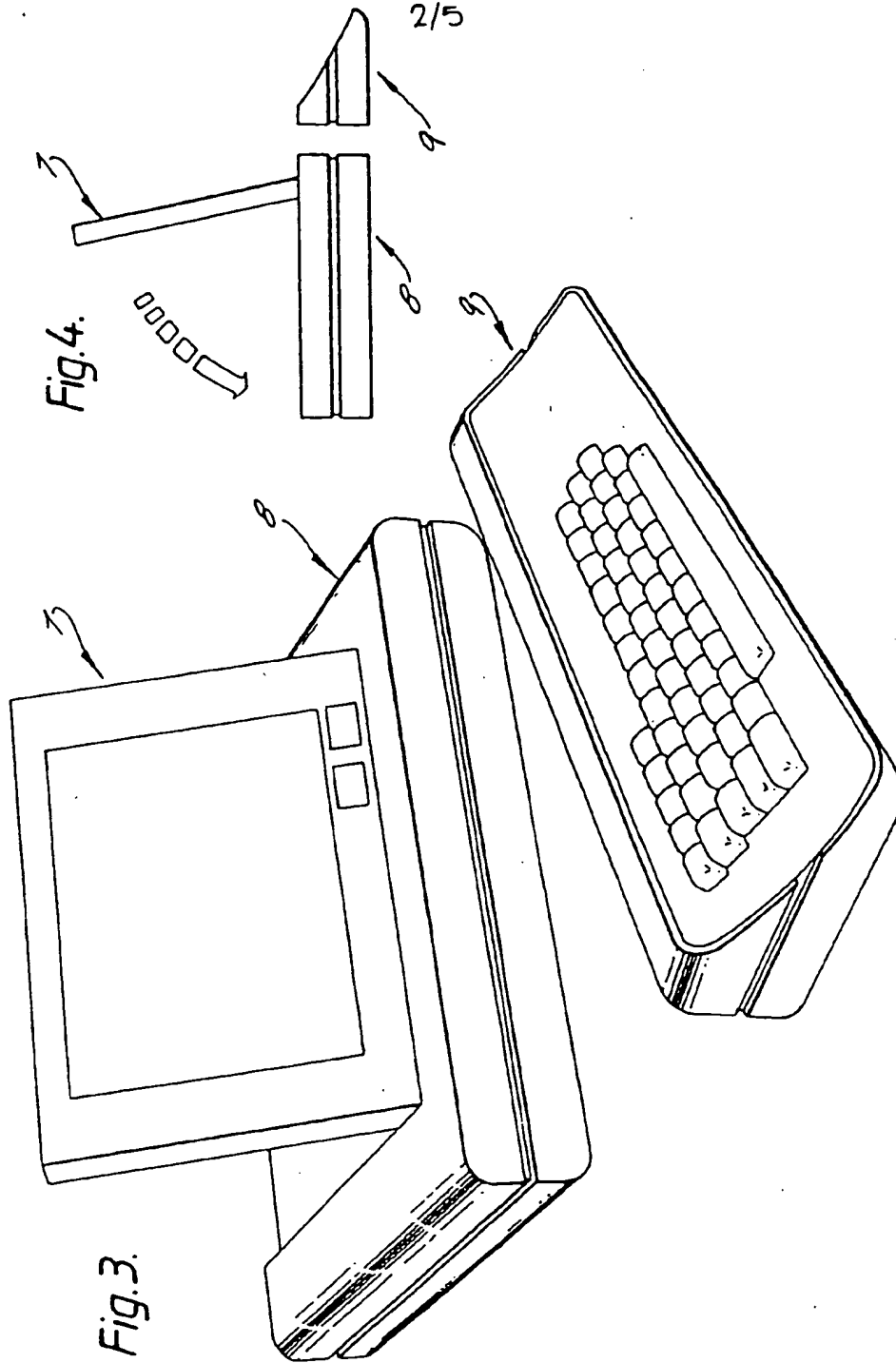

Fig. 2.





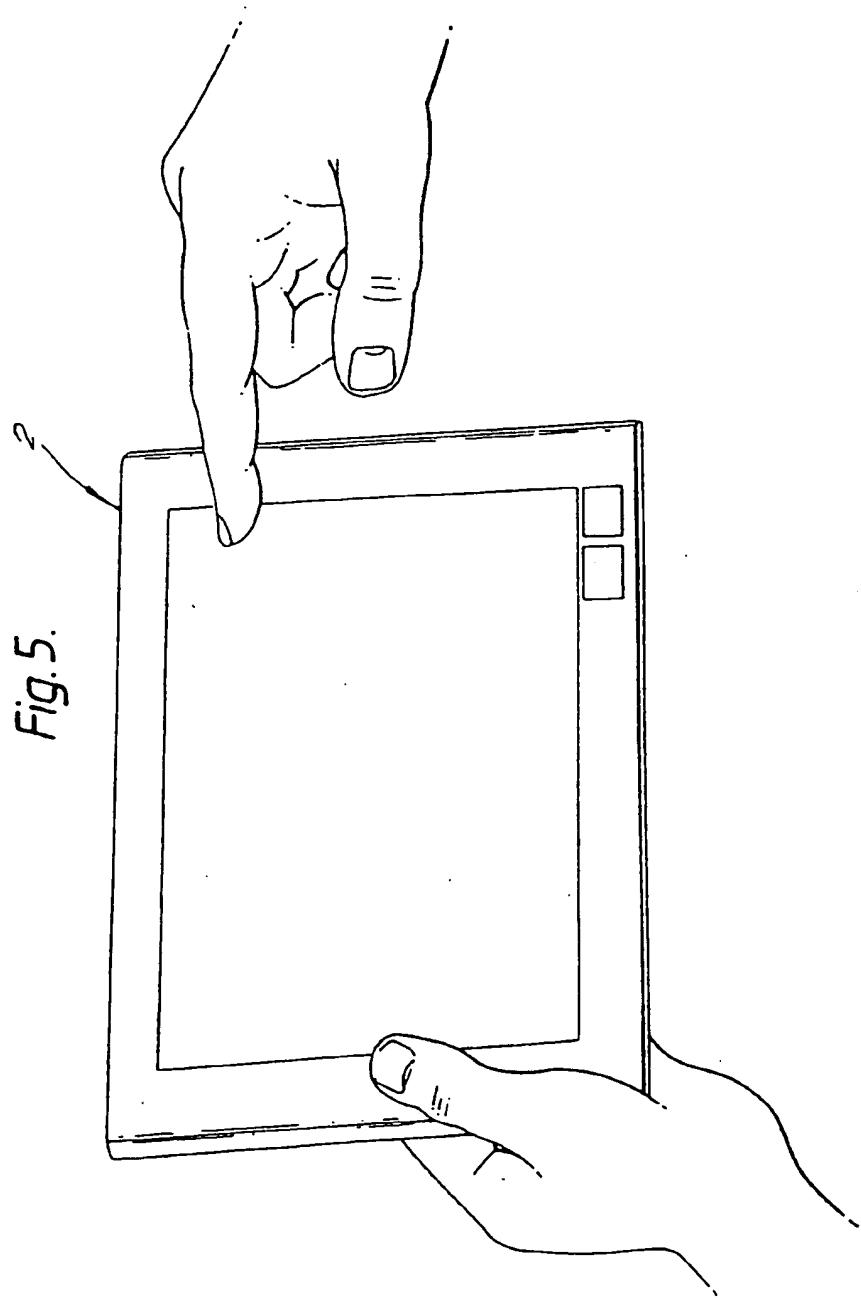

Fig. 5.

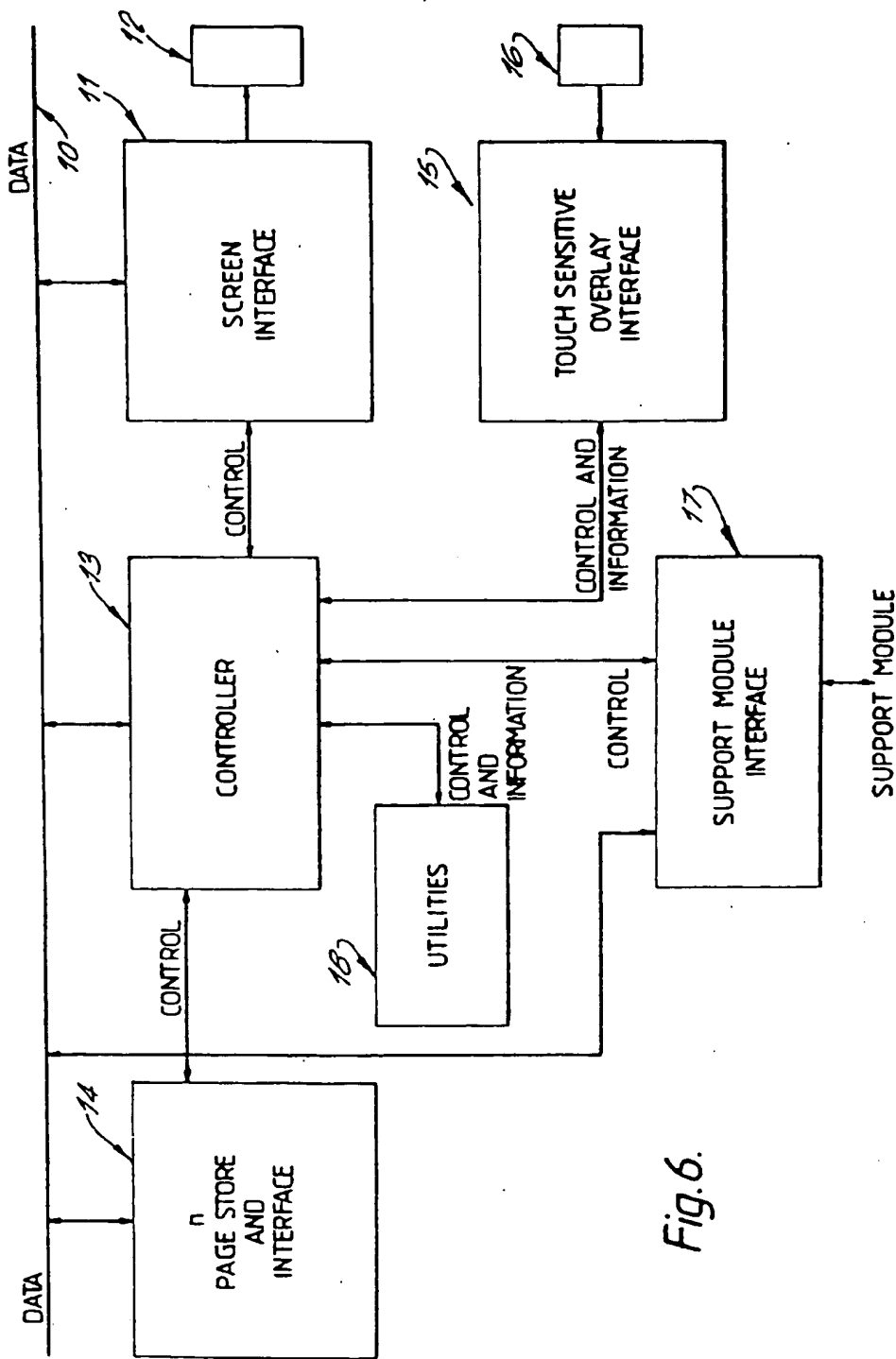

Fig. 6.

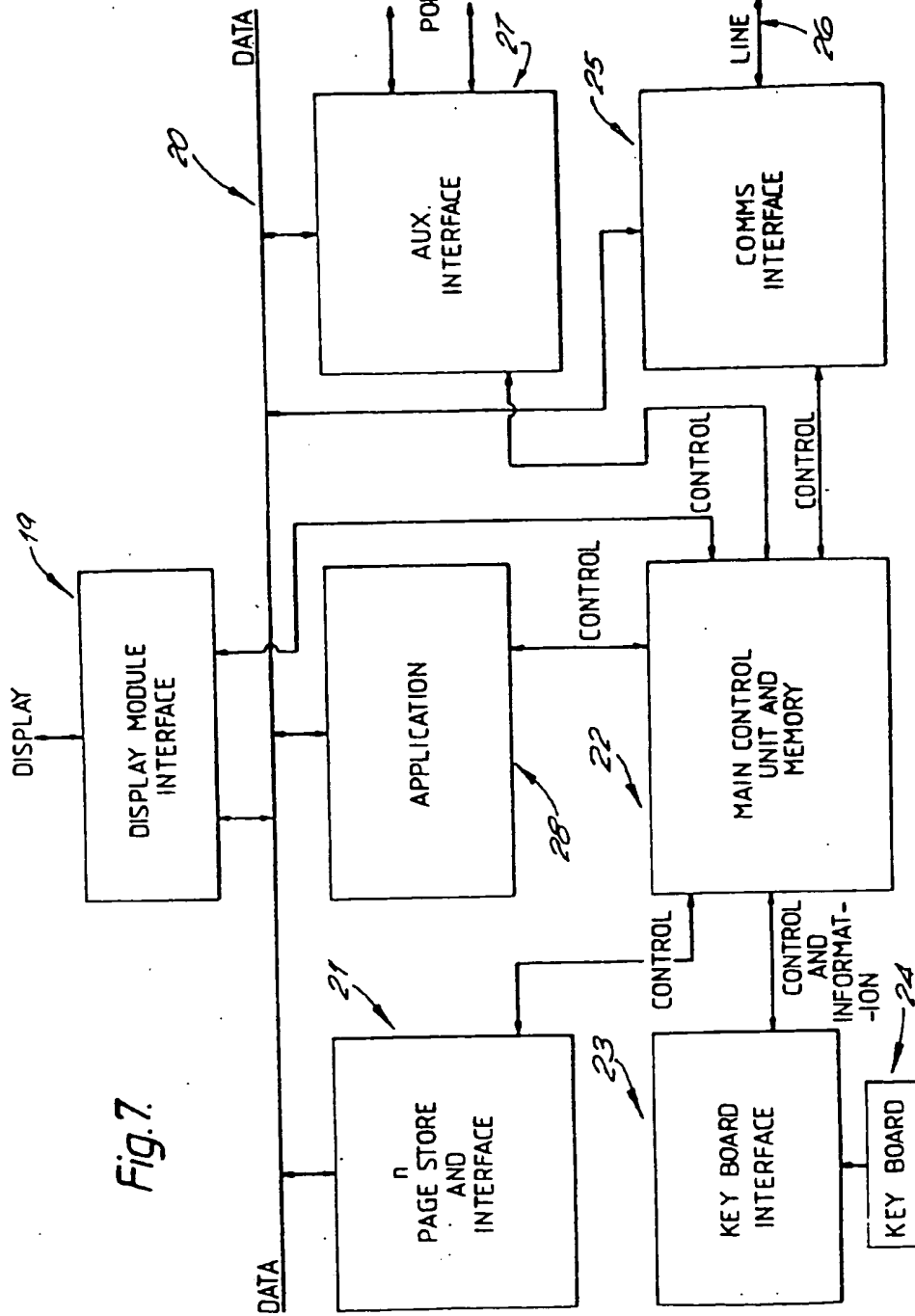

Fig. 7.



European Patent
Office

EUROPEAN SEARCH REPORT

0149762
Application number

EP 84 11 4411

DOCUMENTS CONSIDERED TO BE RELEVANT			
Category	Citation of document with indication, where appropriate, of relevant passages	Relevant to claim	CLASSIFICATION OF THE APPLICATION (Int. Cl. *)
Y	US-A-4 224 615 (PENZ) * Abstract; column 1, lines 46-55; column 3, lines 27-38; figures 3a,3b,3c,4 *	1-3	G 06 F 1/00 G 06 F 3/03B
Y	DE-A-2 947 793 (HAEFNER) * Whole document *	1-3	
Y	US-A-4 125 871 (MARTIN) * Abstract; column 2, lines 55-63; column 3, lines 16-23 *	1,2	
A	EP-A-0 078 895 (KLEIN) * Abstract; figure 2 *	1	
A	CHIP ZEITSCHRIFT FÜR MIKROCOMPUTER-TECHNIK, no. 10, October 1983, pages 72-74, Würzburg, DE; "Designstudie einer mobilen Datenstation"	1,6,7	TECHNICAL FIELDS SEARCHED (Int. Cl. *) G 06 F 1/00 G 06 F 3/02 G 06 F 3/03B
The present search report has been drawn up for all claims			
Place of search THE HAGUE		Date of completion of the search 11-03-1985	Examiner CERVANTES J.P.J.
CATEGORY OF CITED DOCUMENTS X : particularly relevant if taken alone Y : particularly relevant if combined with another document of the same category A : technological background O : non-written disclosure P : intermediate document T : theory or principle underlying the invention E : earlier patent document, but published on, or after the filing date D : document cited in the application L : document cited for other reasons & : member of the same patent family, corresponding document			

EP Form 1000 (01/83)

HSD0012876

**This Page is Inserted by IFW Indexing and Scanning
Operations and is not part of the Official Record**

BEST AVAILABLE IMAGES

Defective images within this document are accurate representations of the original documents submitted by the applicant.

Defects in the images include but are not limited to the items checked:

- BLACK BORDERS
- IMAGE CUT OFF AT TOP, BOTTOM OR SIDES
- FADED TEXT OR DRAWING
- BLURRED OR ILLEGIBLE TEXT OR DRAWING
- SKEWED/SLANTED IMAGES
- COLOR OR BLACK AND WHITE PHOTOGRAPHS
- GRAY SCALE DOCUMENTS
- LINES OR MARKS ON ORIGINAL DOCUMENT
- REFERENCE(S) OR EXHIBIT(S) SUBMITTED ARE POOR QUALITY
- OTHER: _____

IMAGES ARE BEST AVAILABLE COPY.

As rescanning these documents will not correct the image problems checked, please do not report these problems to the IFW Image Problem Mailbox.